

# JM CUSTOM MOLDING PROFILES

## MISCELLANEOUS PROFILES

							
MISC-4 1 $\frac{3}{16}$ " X 2 $\frac{3}{4}$ "	Page # M-1	MISC-8 $\frac{3}{4}$ " X 1 $\frac{5}{16}$ "	Page # M-1	MISC-12 $1\frac{13}{16}$ " X 1 $\frac{1}{4}$ "	Page # M-1	MISC-16 1" X 2"	Page # M-1
							
BAR-4 1 $\frac{3}{4}$ " X 6"	Page # M-2	ARROW-4 $\frac{3}{4}$ " X $\frac{3}{4}$ "	Page # M-2	ARROW-8 $\frac{9}{16}$ " X $\frac{9}{16}$ "	Page # M-2	MISC-35 $\frac{13}{16}$ " X 1"	Page # M-3
				 MISC-40 1" X 5"			
MISC-36 1 $\frac{1}{4}$ " X 2 $\frac{1}{4}$ "	Page # M-3	MISC-37 1 $\frac{3}{4}$ " X 2 $\frac{1}{2}$ "	Page # M-3	MISC-40 1" X 5"H	Page # M-3		Page #
	Page #		Page #		Page #		Page #
	Page #		Page #		Page #		Page #

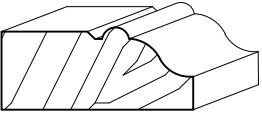
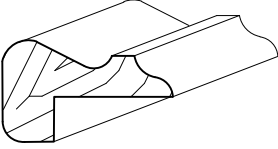
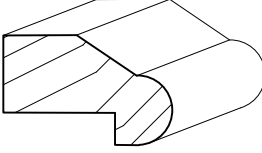
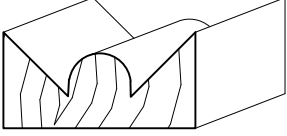
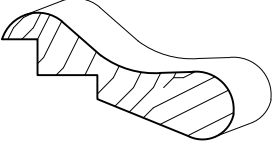
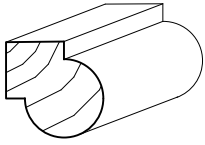
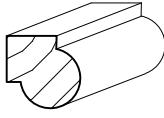
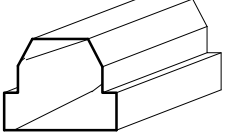
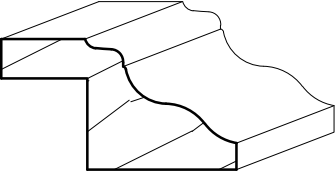
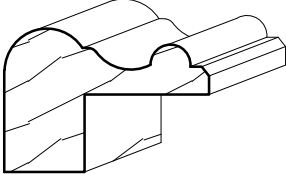
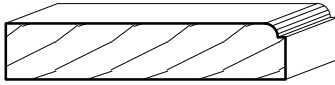

# MISCELLANEOUS

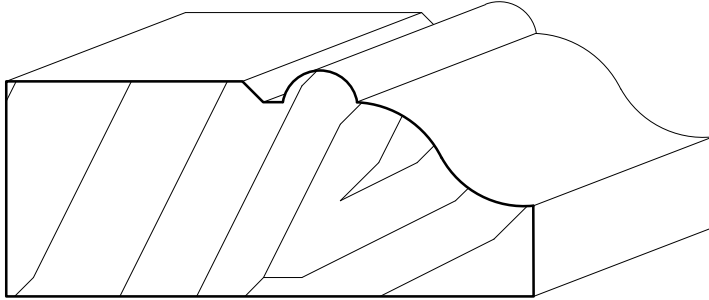

MISC-4  
 $1 \frac{3}{16}'' \times 2 \frac{3}{4}''$

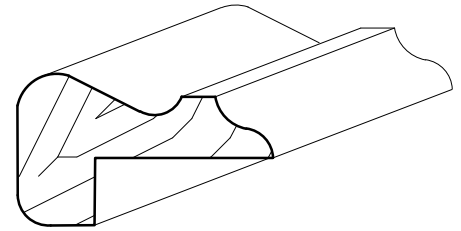

MISC-8  
 $\frac{3}{4}'' \times 1 \frac{5}{16}''$

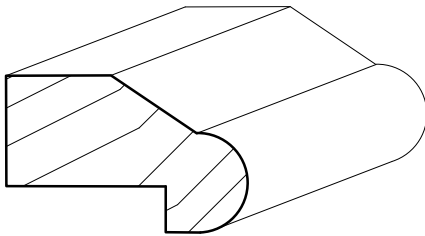

MISC-12  
 $1 \frac{3}{16}'' \times 1 \frac{1}{4}''$

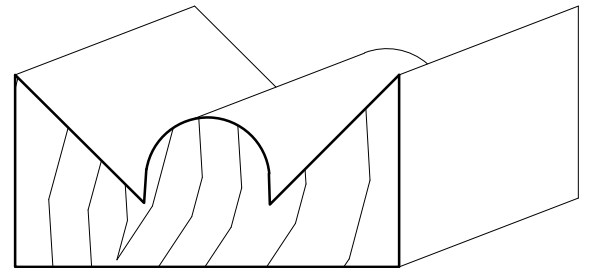

MISC-16  
 $1'' \times 2''$

# MISCELLANEOUS

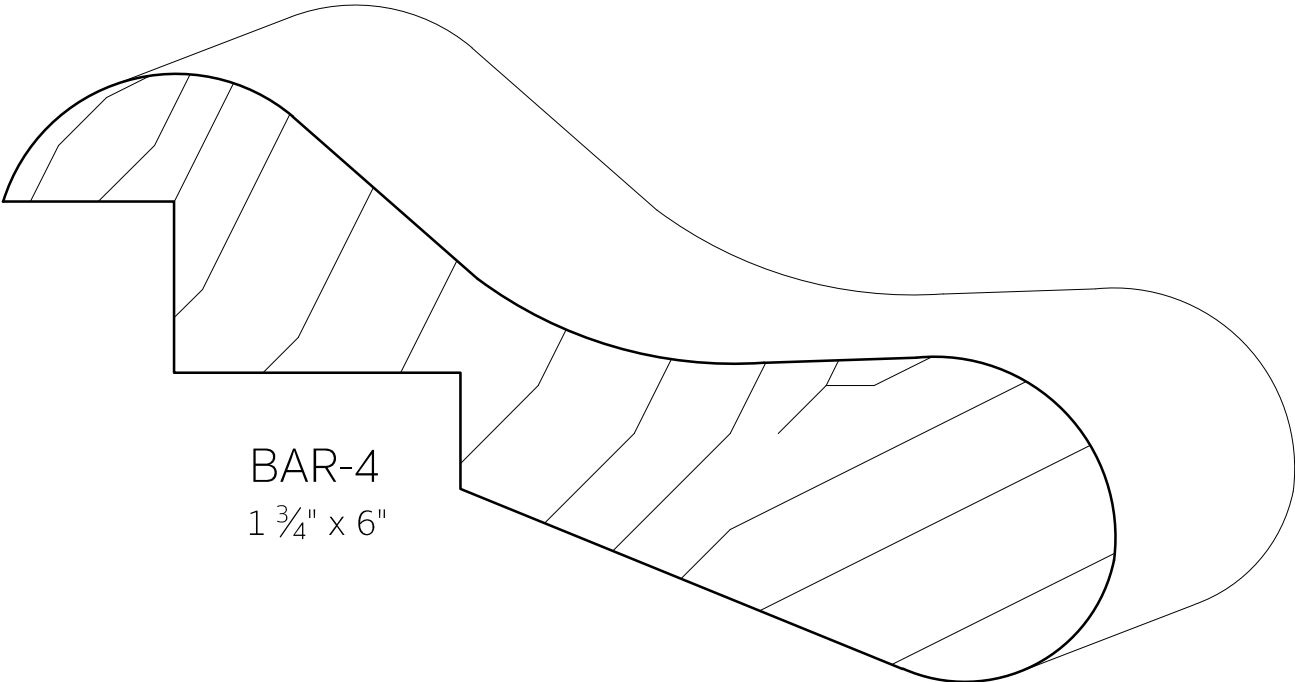

BAR-4  
1 3/4" x 6"

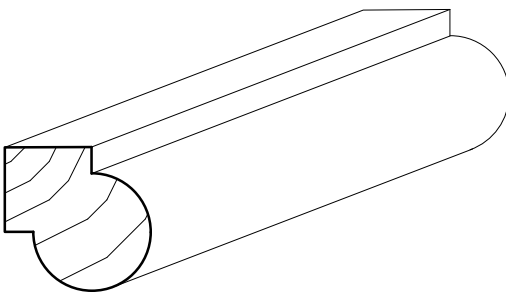

AAROW-4  
3/4" X 3/4"

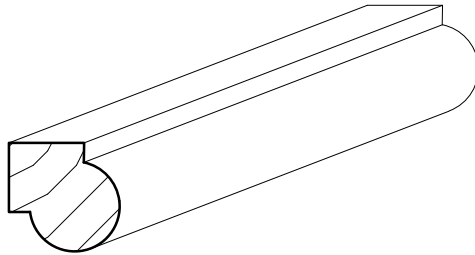

AAROW-8  
9/16" X 9/16"

M-2

# MISCELLANEOUS

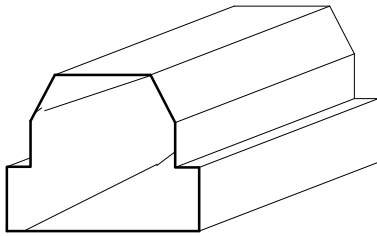

MISC-35

$\frac{13}{16} \times 1"$

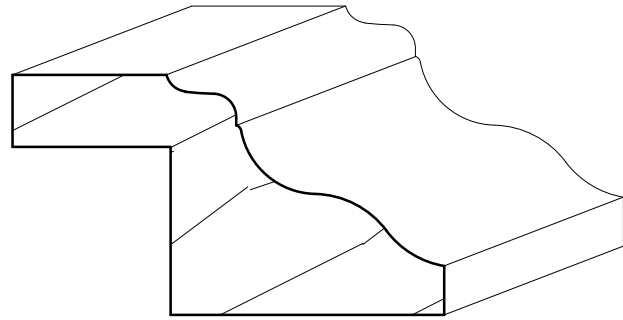

MISC-36

$1 \frac{1}{4} \times 2 \frac{1}{4}"$

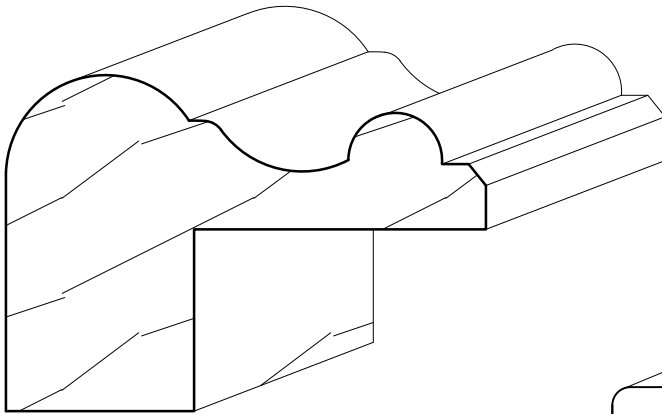

MISC-37

$1 \frac{3}{4} \times 2 \frac{1}{2}"$

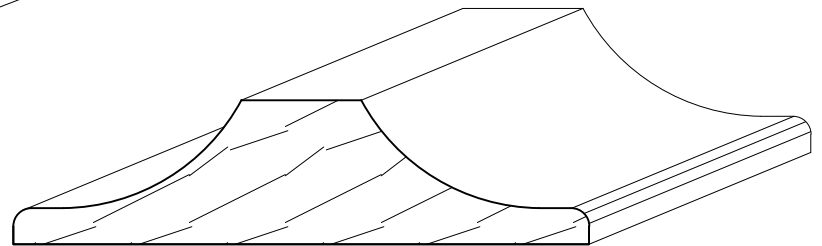

MISC-GLASS HOLDER

$\frac{3}{4} \times 3"$

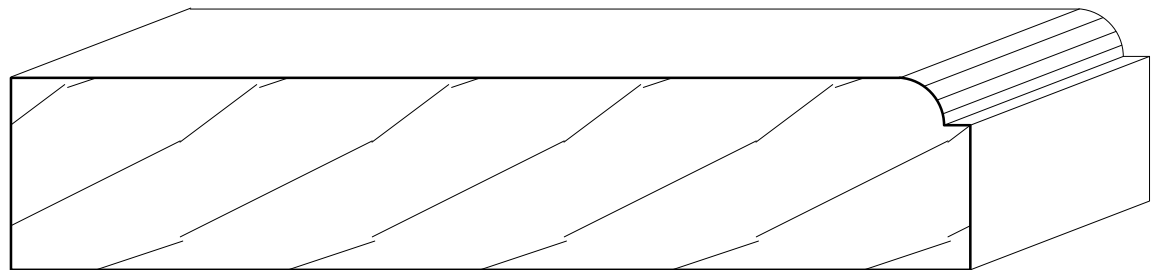

MISC-40

$1 \times 5"$

# MISCELLANEOUS