

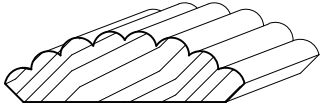



JM CUSTOM MOLDING PROFILES

REEDED PROFILES

							
RC-4 $\frac{7}{8}'' \times 3''$	Page # RE-1	REEDED-1 $\frac{3}{8}'' \times 4''$	Page # RE-2	REEDED CASING-2 $\frac{5}{8}'' \times 2\frac{5}{8}''$	Page # RE-2	REEDED-3 $\frac{3}{4}'' \times 4''$	Page # RE-2
							
REEDED-5 $\frac{1}{4}'' \times 4\frac{1}{4}''$	Page #		Page #		Page #		Page #
	Page #		Page #		Page #		Page #
	Page #		Page #		Page #		Page #
	Page #		Page #		Page #		Page #

REEDED COLUMN

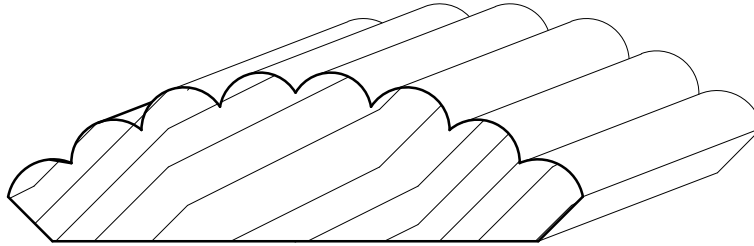

RC-4

$\frac{7}{8}$ " X 3"

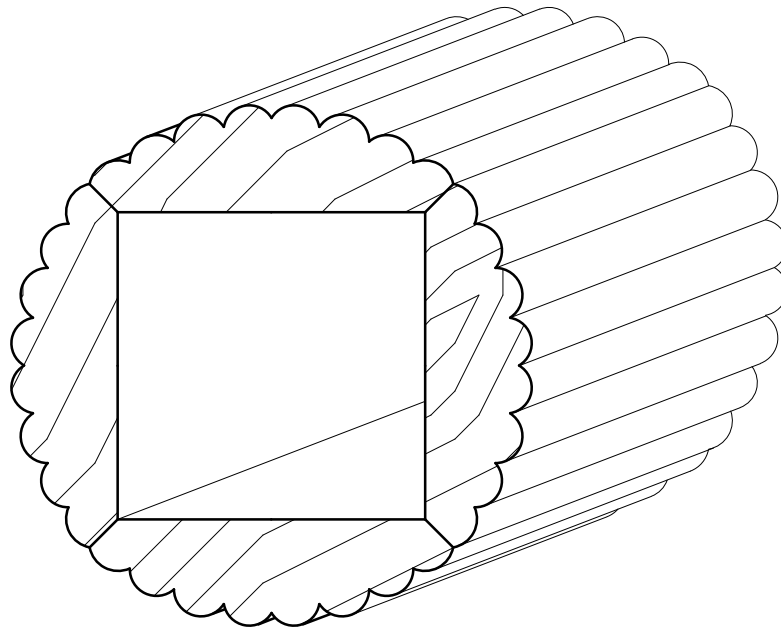

EXAMPLE OF
REEDED COLUMN

RE-1

REEDED

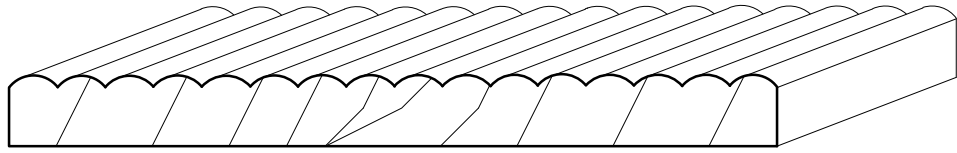

REEDED-1

$\frac{3}{8}$ " X 4"

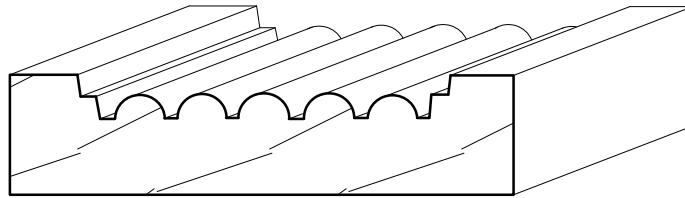

REEDED CASING-2

$\frac{5}{8}$ " X $2\frac{5}{8}$ " READED CASING 2

$\frac{3}{4}$ " X $2\frac{3}{4}$ " X $2\frac{3}{4}$ " - S4S ROSETTE

$\frac{3}{4}$ " X $2\frac{3}{4}$ " X $5\frac{1}{2}$ " - S4S PLINTH

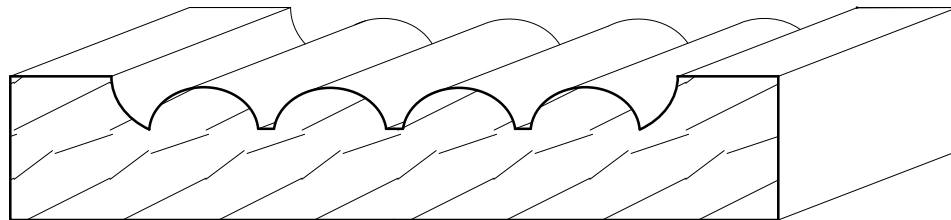

REEDED-3

$\frac{3}{4}$ " X 4"

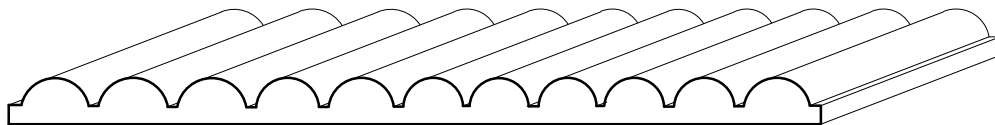

REEDED -5

$\frac{1}{4}$ " X $4\frac{1}{4}$ "

RE-2